

Display Series 477/801

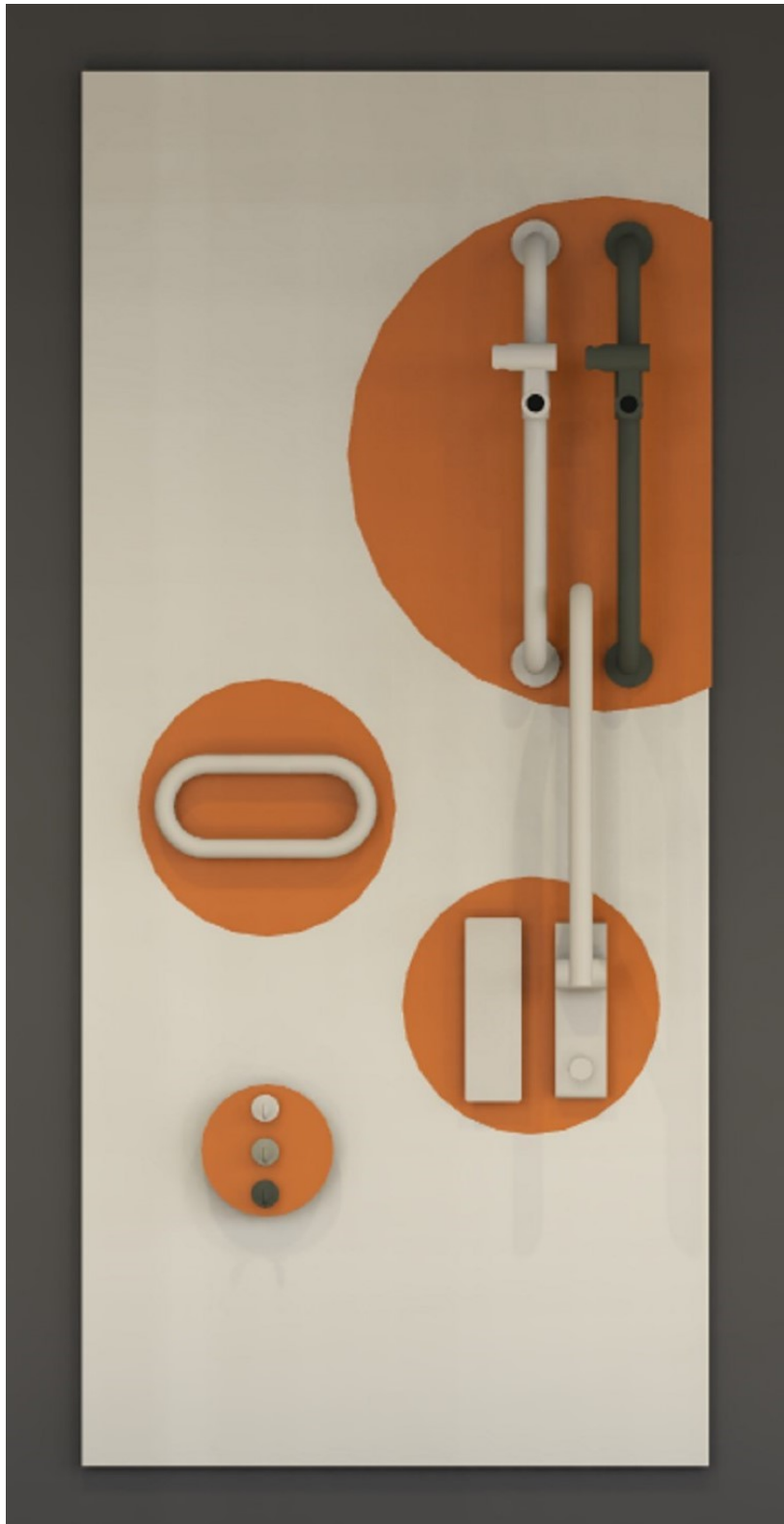

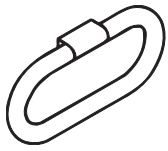

Product data sheet
Range 477 Towel ring 477.09B300

HEWI

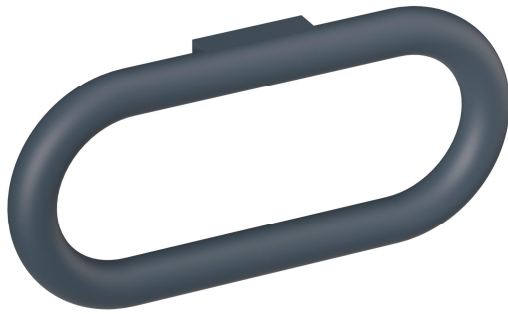

[Click for more information](#)

Range 477 Towel ring 477.09B300

- elongated ring
- for hanging up towels and other pieces of clothing
- the ring is pivoted and locks at approx. 30°
- 320 mm wide and 150 mm high
- made of high-quality matt polyamide in HEWI colours 99 (pure white), 98 (signal white), 97 (light grey), 95 (stone grey) and 92 (anthracite grey)

Article no.: HEWI 477.09B300



Dimensions

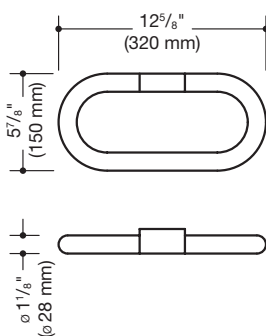

Colors



Polyamide, mat

Alternative colors

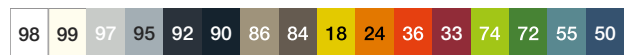

Polyamide

Technical information subject to alteration, August 27th, 2020

HEWI Inc.
350 Fifth Avenue, Suite 5220 Phone: 866 853-8003
New York, NY 10118

hewi@hewi.us
www.hewi.com



Product data sheet
Range 477 Single hook (small) 477.90B010

HEWI



[Click for more information](#)

Range 477 Single hook (small) 477.90B010

- right-angled bend, cylindrical hook with fixing rose
- the hook is for hanging up pieces of clothing, towels and utensils
- anti-theft protection through concealed screw fixing
- 45 mm deep, rose diameter 50 mm
- made of high-quality matt polyamide according to HEWI colour chart

Article no.: HEWI 477.90B010



Dimensions

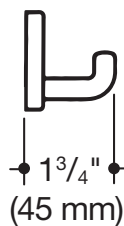
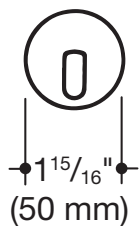

Colors

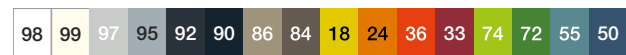

Polyamide, mat

Alternative colors

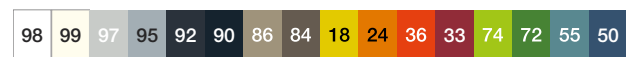

Polyamide

Technical information subject to alteration, August 11th, 2020

HEWI Inc.
350 Fifth Avenue, Suite 5220 Phone: 866 853-8003
New York, NY 10118

hewi@hewi.us
www.hewi.com

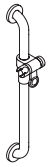

Product data sheet

Grab bar with shower head holder (ADA) 801.33BUS100

HEWI



[Click for more information](#)

Grab bar with shower head holder (ADA) 801.33BUS100

- vertical rail curved at right-angles at the ends with fixing roses and shower head holder
- suitable for handheld shower heads from various manufacturers
- shower head holder can be tilted continuously and its height can be adjusted by pulling or pushing a broad lever
- functional area of the shower head holder in high-quality, glossy polyamide
- cone-shaped insert on the shower head holder makes it easier to mount the handheld shower head
- with corrosion-protected steel core throughout
- wall mounting with wall-specific fixing material and roses from HEWI
- c to c 24" (610 mm)
- 2 3/4 inch (70 mm) deep, rail diameter 1 5/16 inch (33 mm), rose diameter 2 3/4 inch (70 mm)
- maximum loading capacity 330 lbs (150 kg)
- made of high-quality matt polyamide in HEWI colours 99 (pure white), 95 (stone grey) and 92 (anthracite grey)
- meets the requirements of 2010 ADA standards and ICC/ANSI A117.1-2017



ADA compliant

Dimensions

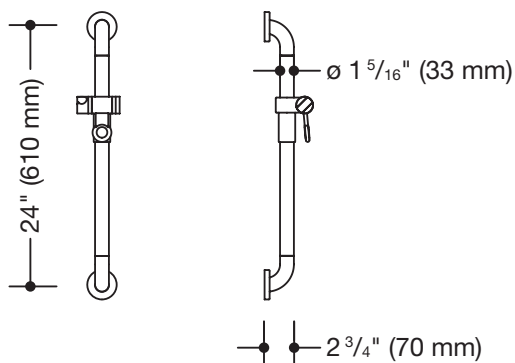

Colors

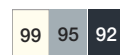

Polyamide, mat

Alternative colors

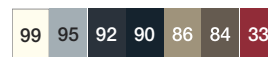

Polyamide

Technical information subject to alteration, August 12th, 2021

HEWI Inc.
350 Fifth Avenue, Suite 5220 Phone: 866 853-8003
New York, NY 10118

hewi@hewi.us
www.hewi.com

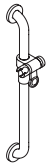

Product data sheet

Grab bar with shower head holder (ADA) 801.33US100

HEWI



[Click for more information](#)

Grab bar with shower head holder (ADA) 801.33US100

- vertical rail curved at right-angles at the ends with fixing roses and shower head holder
- suitable for handheld shower heads from various manufacturers
- shower head holder can be tilted continuously and its height can be adjusted by pulling or pushing a broad lever
- cone-shaped insert on the shower head holder makes it easier to mount the handheld shower head
- with corrosion-protected steel core throughout
- wall mounting with wall-specific fixing material and roses from HEWI
- c to c 24" (610 mm)
- 2 3/4 inch (70 mm) deep, rail diameter 1 5/16 inch (33 mm), rose diameter 2 3/4 inch (70 mm)
- maximum loading capacity 330 lbs (150 kg)
- made from high-grade synthetic material in the HEWI colors 99 (pure white), 95 (stone gray), 92 (anthracite gray), 90 (jet black), 86 (sand), 84 (umber) and 33 (ruby red)
- meets the requirements of 2010 ADA standards and ICC/ANSI A117.1-2017



ADA compliant

Dimensions

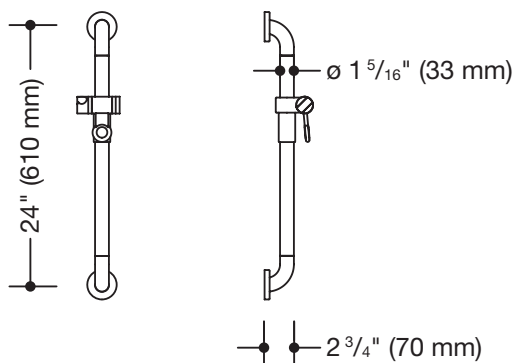

Colors



Polyamide

Alternative colors



Polyamide, mat

Technical information subject to alteration, August 12th, 2021

HEWI Inc.
350 Fifth Avenue, Suite 5220 Phone: 866 853-8003
New York, NY 10118

hewi@hewi.us
www.hewi.com

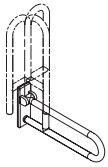

Product data sheet

Range 801 mobile hinged support rail (rotatable) 801.50B107

HEWI



Similar picture

[Click for more information](#)

Range 801 mobile hinged support rail (rotatable) 801.50B107

- two parallel rails running one above the other joined by a connecting bend
- for holding on to and providing support
- weight capacity 220 lbs (100 kg)
- with continuous, corrosion resistant steel core
- can be folded upwards and, folded downwards with braking mechanism, in raised position can be turned to left or right towards the wall
- for mobile use
- for easy and flexible retrofitting on existing, preassembled mounting plate 950.50.016, must be ordered separately
- toolless and quick installation by simple attachment of the mobile hinged support rail
- secured by fixing screw to prevent unintentional removal
- 23 5/8 inch (600 mm) projection, 9 15/16 inch (252 mm) high and 3 1/16 inch (78 mm) deep, 1 5/16 inch (33 mm) rail diameter
- made of high-quality matt polyamide in HEWI colours 99 (pure white), 98 (signal white), 97 (light grey), 95 (stone grey) and 92 (anthracite grey)
- toilet roll holder 801.50B010 and 801.50B011, WC flushing mechanism (radio-controlled) 801.50B060 and floor supports 950.50B021XA and 950.50B023XA for retrofitting
- CE marking according to Directive 93/42 / EEC
- fulfils the DIN 18040, ÖNORM B1600/1601 and SIA 500 requirements



Dimensions

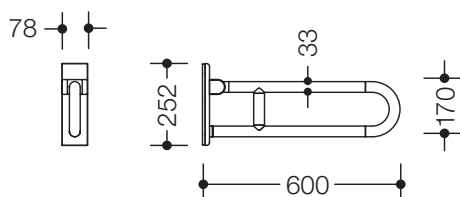

Colors



Polyamide, mat

Alternative colors

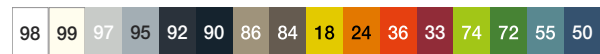

Polyamide

Technical information subject to alteration, March 20th, 2020

HEWI Inc.
350 Fifth Avenue, Suite 5220 Phone: 866 853-8003
New York, NY 10118

hewi@hewi.us
www.hewi.com



Product data sheet

Mounting plate for mobile hinged support rails, Series 805 Classic and Series 801 950.50.016

HEWI



[Click for more information](#)

Mounting plate for mobile hinged support rails, Series 805 Classic and Series 801 950.50.016

- rectangular mounting plate with fixing screw
- serves to hold and fix the mobile hinged support rails 805.50.1..., 805.50.2..., 801.50.1..., 801.50D1..., 801.50B1..., 801.50.2..., 801.50D2... and 801.50B2...
- 74 mm wide, 249 mm high, 18 mm deep
- made of stainless steel, satin finish
- for mounting with corrosion-free and tested HEWI fixing material for different wall structures (to be ordered separately)
- sealing tape for sealing the fixing points is included in the scope of delivery

Article no.: HEWI 950.50.016

Dimensions

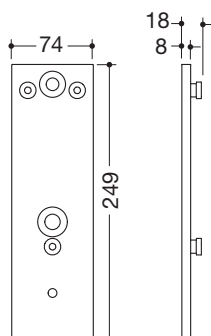

Surface

XA | satin

Technical information subject to alteration, March 20th, 2020

HEWI Inc.
350 Fifth Avenue, Suite 5220
New York, NY 10118

Phone: 866 853-8003

hewi@hewi.us
www.hewi.com



Product data sheet

Mounting plate with cover for the mobile hinged support rails, Series 801 950.50.10190

HEWI



[Click for more information](#)

Mounting plate with cover for the mobile hinged support rails, Series 801 950.50.10190

- rectangular mounting plate with matching, rectangular cover
- serves to hold and fix the mobile hinged support rails 801.50.1..., 801.50D1..., 801.50B1..., 801.50.2..., 801.50D2... and 801.50B2...
- 82 mm wide, 265 mm high, 19 mm deep
- mounting plate made of stainless steel, satin finish
- for mounting with corrosion-free and tested HEWI fixing material for various wall structures (to be ordered separately)
- sealing tape for sealing the fixing points is included in the scope of delivery
- cover made of high-quality polyamide in the HEWI colours 98 (signal white) or 99 (pure white)

Article no.: HEWI 950.50.10190

Dimensions

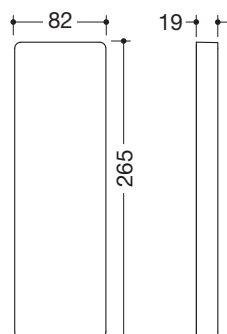

Colors

98	99
----	----

Technical information subject to alteration, March 20th, 2020

HEWI Inc.
350 Fifth Avenue, Suite 5220 Phone: 866 853-8003
New York, NY 10118

hewi@hewi.us
www.hewi.com