

Display Series 815

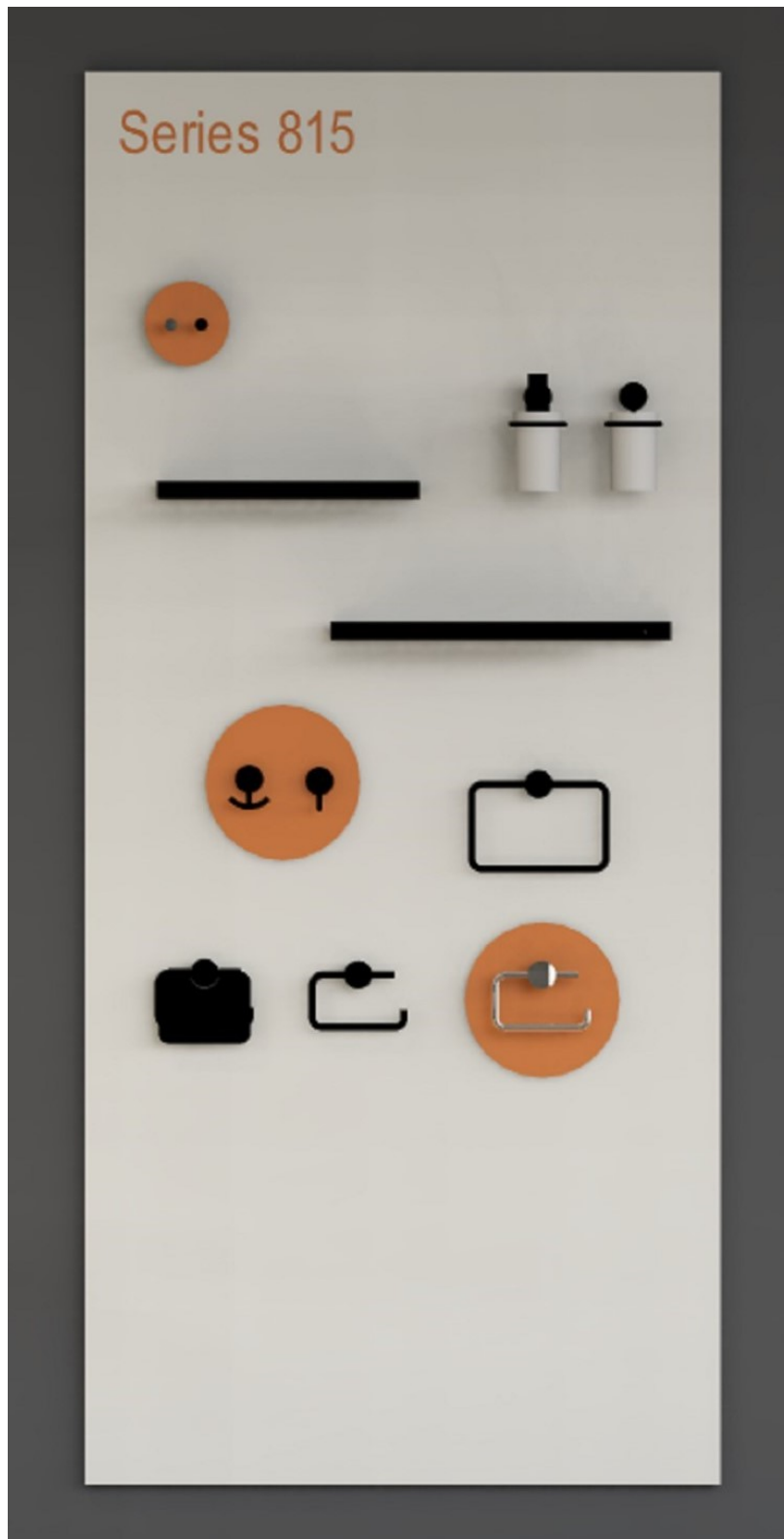

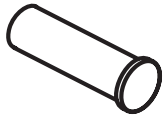

Product data sheet
System 162 Robe hook 162.90.01040

HEWI

System 162 Robe hook 162.90.01040

- cylindrical robe hook
- made of metal, high-quality chrome-plated
- 1 3/8 inch (35 mm) long, diameter 9/16 inch (15 mm)
- for wall mounting, concealed fixing
- incl. non-corrosive HEWI fixing material



[Click for more information](#)

Dimensions

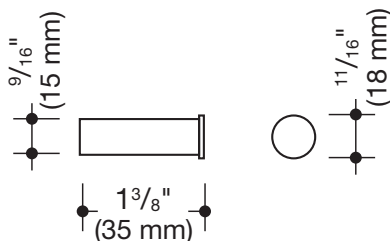

Surface



Alternative surfaces



Technical information subject to alteration, March 19th, 2020

HEWI Inc.
350 Fifth Avenue, Suite 5220 Phone: 866 853-8003
New York, NY 10118

hewi@hewi.us
www.hewi.com

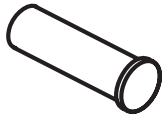

Product data sheet
System 162 Hook 162.90.01060

HEWI

System 162 Hook 162.90.01060

- cylindrical hook
- made of metal, powder-coated in the HEWI colours DX (matt white), DC (matt black), AY (matt light gray pearl mica) and SC (matt dark gray pearl mica)
- 1 3/8 inch (35 mm) long, diameter 9/16 inch (15 mm)
- for wall mounting, concealed fixing
- incl. non-corrosive HEWI fixing materials



[Click for more information](#)

Dimensions

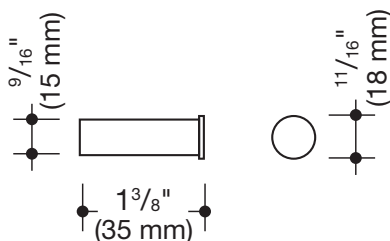

Surfaces/Colors



Alternative surfaces



Technical information subject to alteration, April 3rd, 2021

HEWI Inc.
350 Fifth Avenue, Suite 5220 Phone: 866 853-8003
New York, NY 10118

hewi@hewi.us
www.hewi.com



Product data sheet
System 815 Tumbler with holder 815.04.11045

HEWI



System 815 Tumbler with holder 815.04.11045

- ring-shaped wall-mounted bracket with tumbler
- bracket made of stainless steel, high-quality chrome-plated
- tumbler made of high-quality, satin-finish crystal glass
- 83 mm wide, 154 mm high and 104 mm deep
- for wall mounting, concealed rose fixing
- including non-corrosive HEWI fixing material

Article no.: HEWI 815.04.11045



[Click for more information](#)

Dimensions

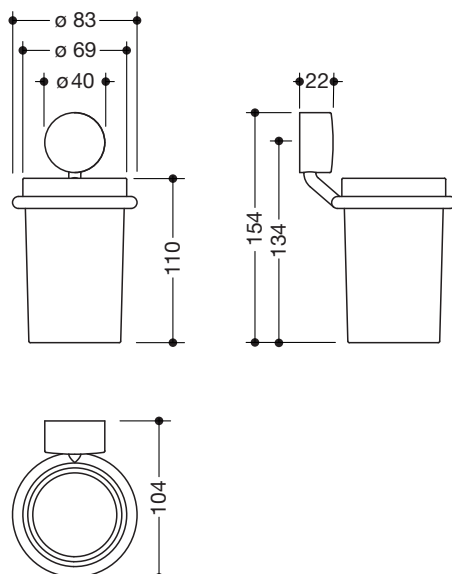

Surface/Material

Chr

Alternative surface/material

DC

Technical information subject to alteration, March 25th, 2021

HEWI Inc.
350 Fifth Avenue, Suite 5220 Phone: 866 853-8003
New York, NY 10118

hewi@hewi.us
www.hewi.com

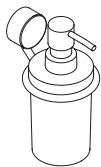

Product data sheet

System 815 Soap or disinfectant dispenser with holder 815.06.11065

HEWI



System 815 Soap or disinfectant dispenser with holder 815.06.11065

- ring-shaped wall-mounted bracket with soap dispenser
- bracket made of stainless steel, matt black powder-coated
- soap dispenser made of high-quality, satin-finish crystal glass
- serves to hold commercially available liquid soap, disinfectants and gels
- high-quality chrome-plated pump head
- 83 mm wide, 167 mm high and 104 mm deep
- for wall mounting, concealed rose fixing
- including non-corrosive HEWI fixing material

Article no.: HEWI 815.06.11065

[Click for more information](#)

Dimensions

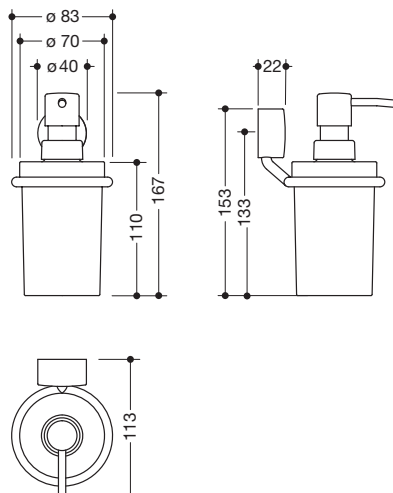

Surface/Material

DC

Alternative surface/material

Chr

Technical information subject to alteration, August 4th, 2021

HEWI Inc.
350 Fifth Avenue, Suite 5220 Phone: 866 853-8003
New York, NY 10118

hewi@hewi.us
www.hewi.com

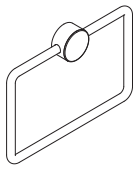

Product data sheet
System 815 Towel ring 815.09.30060

HEWI

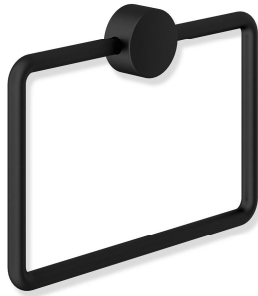

System 815 Towel ring 815.09.30060

- closed towel ring, rectangular with large radii
- for hanging up towels and other pieces of clothing
- the ring can be pivoted
- made of stainless steel, matt black powder-coated
- 200 mm wide and 145 mm high
- for wall mounting, concealed rose fixing
- including non-corrosive HEWI fixing material

Article no.: HEWI 815.09.30060

[Click for more information](#)

Dimensions

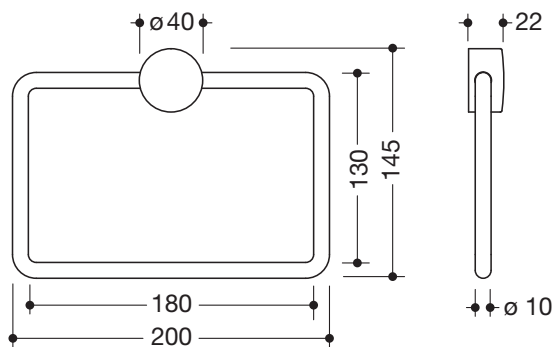

Surface/Material

DC

Alternative surface/material

Chr

Technical information subject to alteration, August 4th, 2021

HEWI Inc.
350 Fifth Avenue, Suite 5220 Phone: 866 853-8003
New York, NY 10118

hewi@hewi.us
www.hewi.com

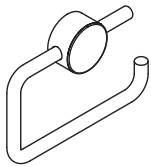

Product data sheet
System 815 Toilet roll holder 815.21.10040

HEWI



System 815 Toilet roll holder 815.21.10040

- U-shaped holder, open on the right-hand side
- hinged
- made of stainless steel, high-quality chrome-plated
- 140 mm wide, 99 mm high, 22 mm deep
- for wall mounting, concealed rose fixing
- including non-corrosive HEWI fixing material

Article no.: HEWI 815.21.10040



[Click for more information](#)

Dimensions

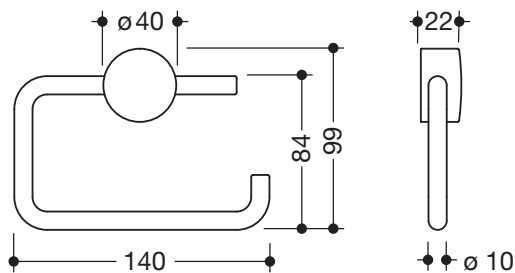

Surface/Material

Chr

Alternative surface/material

DC

Technical information subject to alteration, March 25th, 2021

HEWI Inc.
350 Fifth Avenue, Suite 5220 Phone: 866 853-8003
New York, NY 10118

hewi@hewi.us
www.hewi.com

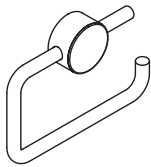

Product data sheet
System 815 Toilet roll holder 815.21.10060

HEWI

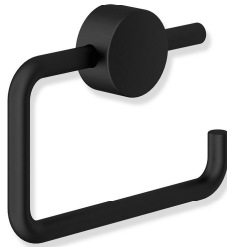

System 815 Toilet roll holder 815.21.10060

- U-shaped holder, open on the right-hand side
- hinged
- made of stainless steel, matt black powder-coated
- 140 mm wide, 99 mm high, 22 mm deep
- for wall mounting, concealed rose fixing
- including non-corrosive HEWI fixing material

Article no.: HEWI 815.21.10060

[Click for more information](#)

Dimensions

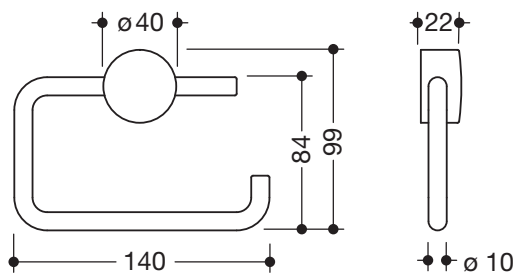

Surface/Material

DC

Alternative surface/material

Chr

Technical information subject to alteration, August 4th, 2021

HEWI Inc.
350 Fifth Avenue, Suite 5220 Phone: 866 853-8003
New York, NY 10118

hewi@hewi.us
www.hewi.com

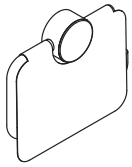

Product data sheet

System 815 Toilet roll holder with cover 815.21.20060

HEWI



[Click for more information](#)

System 815 Toilet roll holder with cover 815.21.20060

- U-shaped holder with cover, open on the right-hand side
- hinged
- made of stainless steel, matt black powder-coated
- 140 mm wide, 120 mm high, 22 mm deep
- for wall mounting, concealed rose fixing
- including non-corrosive HEWI fixing material

Article no.: HEWI 815.21.20060

Dimensions

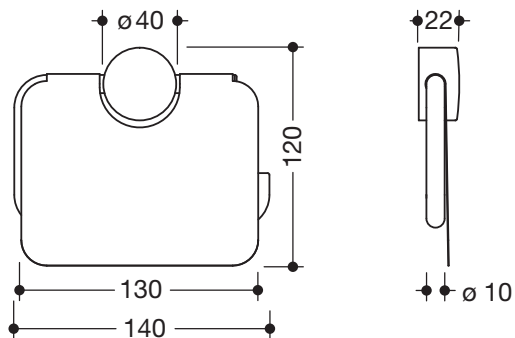

Surface/Material

DC

Alternative surface/material

Chr

Technical information subject to alteration, August 4th, 2021

HEWI Inc.
350 Fifth Avenue, Suite 5220
New York, NY 10118

Phone: 866 853-8003

hewi@hewi.us
www.hewi.com



Product data sheet
System 815 Hook 815.90.01060

HEWI

System 815 Hook 815.90.01060

- hook with fixing rose
- for hanging up towels and other pieces of clothing
- made of stainless steel, matt black powder-coated
- 40 mm wide, 69 mm high, 47 mm deep
- for wall mounting, concealed rose fixing
- including non-corrosive HEWI fixing material

Article no.: HEWI 815.90.01060



[Click for more information](#)

Dimensions

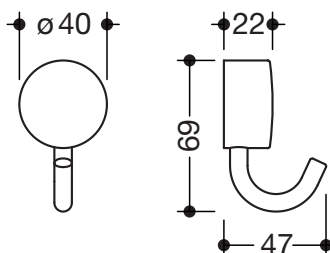

Surface/Material

DC

Alternative surface/material

Chr

Technical information subject to alteration, August 4th, 2021

HEWI Inc.
350 Fifth Avenue, Suite 5220 Phone: 866 853-8003
New York, NY 10118

hewi@hewi.us
www.hewi.com



Product data sheet
System 815 Double hook 815.90.02060

HEWI

System 815 Double hook 815.90.02060

- double hook with fixing rose
- for hanging up towels and other pieces of clothing
- made of stainless steel, matt black powder-coated
- 61 mm wide, 64 mm high, 27 mm deep
- for wall mounting, concealed rose fixing
- including non-corrosive HEWI fixing material

Article no.: HEWI 815.90.02060



[Click for more information](#)

Dimensions

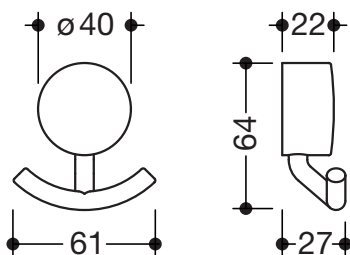

Surface/Material

DC

Alternative surface/material

Chr

Technical information subject to alteration, August 4th, 2021

HEWI Inc.
350 Fifth Avenue, Suite 5220 Phone: 866 853-8003
New York, NY 10118

hewi@hewi.us
www.hewi.com

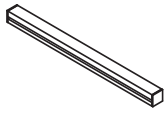

Product data sheet
Wall profile with caps 950.13.0010

HEWI



[Click for more information](#)

Wall profile with caps 950.13.0010

- Hooks and shelves can easily be inserted and removed using the profile
- Additional storage space or hanging space on the wall
- 372 mm long, cross-diameter 25 x 25 mm
- Made of aluminium
- powder-coated in the HEWI colours DX (matt white), DC (matt black), AY (matt light grey pearl mica) and SC (matt dark grey pearl mica)
- Including corrosion-free HEWI fastening material



Dimensions in mm

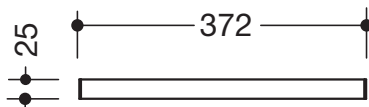

Surfaces/Colours



Technical information subject to alteration, 31st March 2021

HEWI Heinrich Wilke GmbH
Postfach 1260
D-34442 Bad Arolsen

Telefon: +49 5691 82-366
Telefax: +49 5691 82-99366
international@hewi.com
www.hewi.com

HEWI (UK) Limited
Holm Oak Barn, Beluncle Halt
Stoke Road
Hoo Kent ME3 9NT

Phone +44 1634 258 200
Fax +44 1634 250 099
info@hewi.co.uk
www.hewi.com

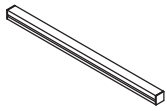

Product data sheet
Wall profile with caps 950.13.0011

HEWI



Wall profile with caps 950.13.0011

- Hooks and shelves can easily be inserted and removed using the profile
- Additional storage space or hanging space on the wall
- 482 mm long, cross-diameter 25 x 25 mm
- Made of aluminium
- powder-coated in the HEWI colours DX (matt white), DC (matt black), AY (matt light grey pearl mica) and SC (matt dark grey pearl mica)
- Including corrosion-free HEWI fastening material

[Click for more information](#)



Dimensions in mm

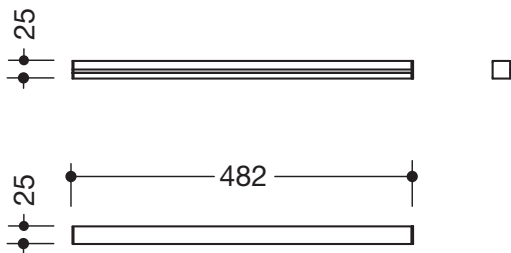

Surfaces/Colours



Technical information subject to alteration, 31st March 2021

HEWI Heinrich Wilke GmbH
Postfach 1260
D-34442 Bad Arolsen

Telefon: +49 5691 82-366
Telefax: +49 5691 82-99366
international@hewi.com
www.hewi.com

HEWI (UK) Limited
Holm Oak Barn, Beluncle Halt
Stoke Road
Hoo Kent ME3 9NT

Phone +44 1634 258 200
Fax +44 1634 250 099
info@hewi.co.uk
www.hewi.com

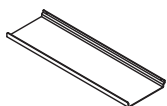

Product data sheet
Shelf 950.13.0014

HEWI

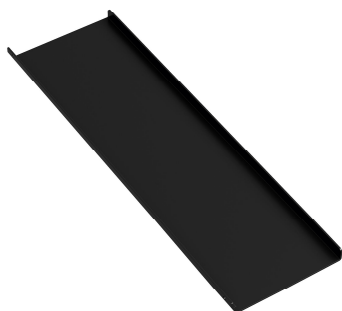

Shelf 950.13.0014

- adaptive additional functions for the wall profiles 950.13.001.. and wash basin model 950.13.20..
- Shelf can easily be inserted and removed in the profile on the wash basin
- Additional storage space on the wall or directly at the wash basin
- Shelf 360 mm wide, 102 mm deep
- Made of high quality stainless steel
- powder-coated in the HEWI colours DX (matt white), DC (matt black), AY (matt light grey pearl mica) and SC (matt dark grey pearl mica)
- Load capacity up to 2 kg

[Click for more information](#)



Dimensions in mm

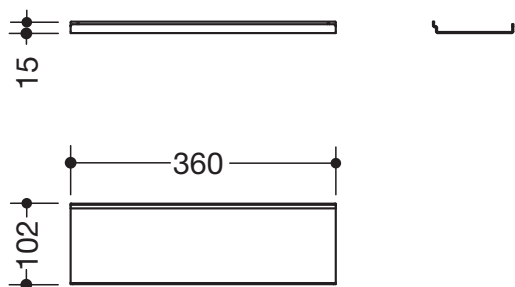

Surfaces/Colours



Technical information subject to alteration, 31st March 2021

HEWI Heinrich Wilke GmbH
Postfach 1260
D-34442 Bad Arolsen

Telefon: +49 5691 82-366
Telefax: +49 5691 82-99366
international@hewi.com
www.hewi.com

HEWI (UK) Limited
Holm Oak Barn, Beluncle Halt
Stoke Road
Hoo Kent ME3 9NT

Phone +44 1634 258 200
Fax +44 1634 250 099
info@hewi.co.uk
www.hewi.com

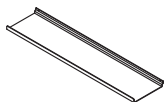

Product data sheet
Shelf 950.13.0017

HEWI

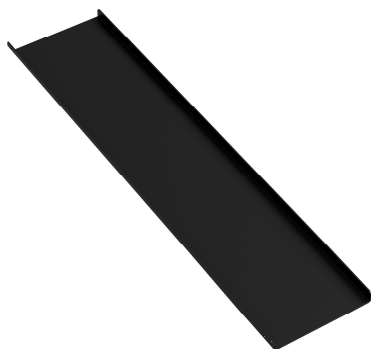

[Click for more information](#)

Shelf 950.13.0017

- adaptive additional functions for the wall profiles 950.13.001.. and wash basin model 950.13.20..
- Shelf can easily be inserted and removed in the profile on the wash basin
- Additional storage space on the wall or directly at the wash basin
- Shelf 470 mm wide, 102 mm deep
- Made of high quality stainless steel
- powder-coated in the HEWI colours DX (matt white), DC (matt black), AY (matt light grey pearl mica) and SC (matt dark grey pearl mica)
- Load capacity up to 2 kg



Dimensions in mm

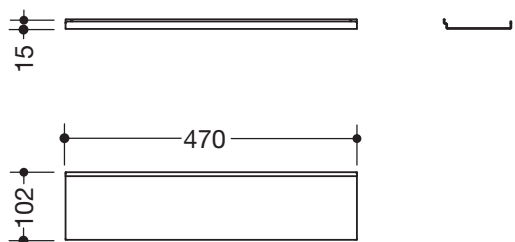

Surfaces/Colours



Technical information subject to alteration, 31st March 2021

HEWI Heinrich Wilke GmbH
Postfach 1260
D-34442 Bad Arolsen

Telefon: +49 5691 82-366
Telefax: +49 5691 82-99366
international@hewi.com
www.hewi.com

HEWI (UK) Limited
Holm Oak Barn, Beluncle Halt
Stoke Road
Hoo Kent ME3 9NT

Phone +44 1634 258 200
Fax +44 1634 250 099
info@hewi.co.uk
www.hewi.com